

CONTROL ROD KITS

Accessories

Technical Data Sheet

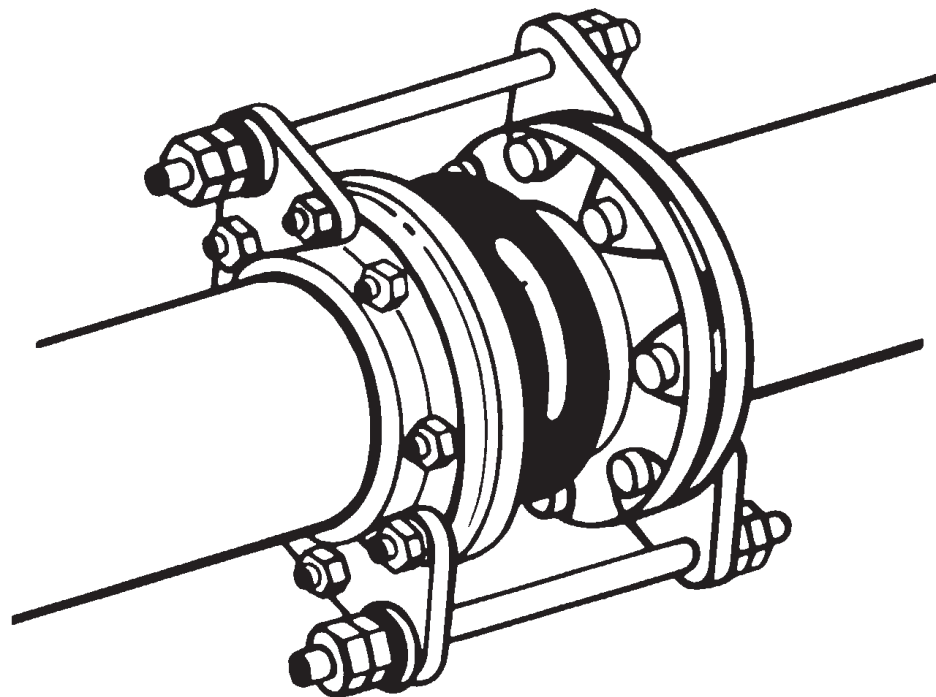

Description

Galvanised steel control rods for PN10 and PN16 flanges.

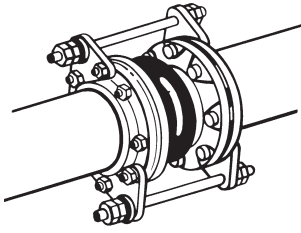

KIT TIRANTS

Accessories

DN		PN	No. of kit	Ref.	Weight Kg
"	mm				
1 1/4	32	10	1	149B5436	2,10
1 1/2	40	10	1	149B5437	1,90
2	50	10	1	149B5438	2,10
2 1/2	65	10	1	149B5439	2,24
3	80	10	1	149B5440	1,90
4	100	10	1	149B5441	2,10
5	125	10	1	149B5442	2,30
6	150	10	1	149B5443	3,65
8	200	10	1	149B5444	3,80
10	250	10	2	149B5445	5,80
12	300	10	2	149B5446	5,25
14	350	10	2	149B5447	5,00
16	400	10	2	149B5448	6,00
18	450	10	2	149B5449	10,00
20	500	10	2	149B5450	11,00
24	600	10	2	149B5451	14,00
8	200	16	1	149B008940	3,80
10	250	16	2	149B008941	5,90
12	300	16	2	149B008942	6,20
14	350	16	2	149B008943	8,30
16	400	16	2	149B008944	10,40
18	450	16	2	149B008945	12,00
20	500	16	2	149B008947	16,00
24	600	16	2	149B008948	17,00

Installation

The control rod kits must be installed when the pressure exceeds the values below.

DN		PSIG	Bar
"	mm		
1 - 4	25 - 100	150	10,3
5 - 10	125 - 250	135	9,3
12 - 14	300 - 350	90	6,2
16 - 24	400 - 600	45	3,1

The descriptions and photographs contained in this product specification sheet are supplied by way of information only and are not binding.

Socla reserves the right to carry out any technical and design improvements to its products without prior notice. Warranty : All sales and contracts for sale are expressly conditioned on the buyer's assent to Socla terms and conditions found on its website at www.socla.com. Socla hereby objects to any term, different from or additional to Socla terms, contained in any buyer communication in any form, unless agreed to in a writing signed by an officer of Socla.



A WATTS Brand

Socla sas

365 rue du Lieutenant Putier • 71530 Virey-Le-Grand • France

Tel. +33 03 85 97 42 00 • Fax +33 03 85 97 42 42

contact@wattswater.com • www.socla.com

ISO 9001 version 2015 / ISO 18001